

※In this solution the piece marked with HANAYAMA is shown in grey.

※ ↗ This arrow shows the movement of the non-colored pieces ("A" for the purposes of this solution).

➡ This arrow shows the movement of the grey pieces ("B" for the purposes of this solution).

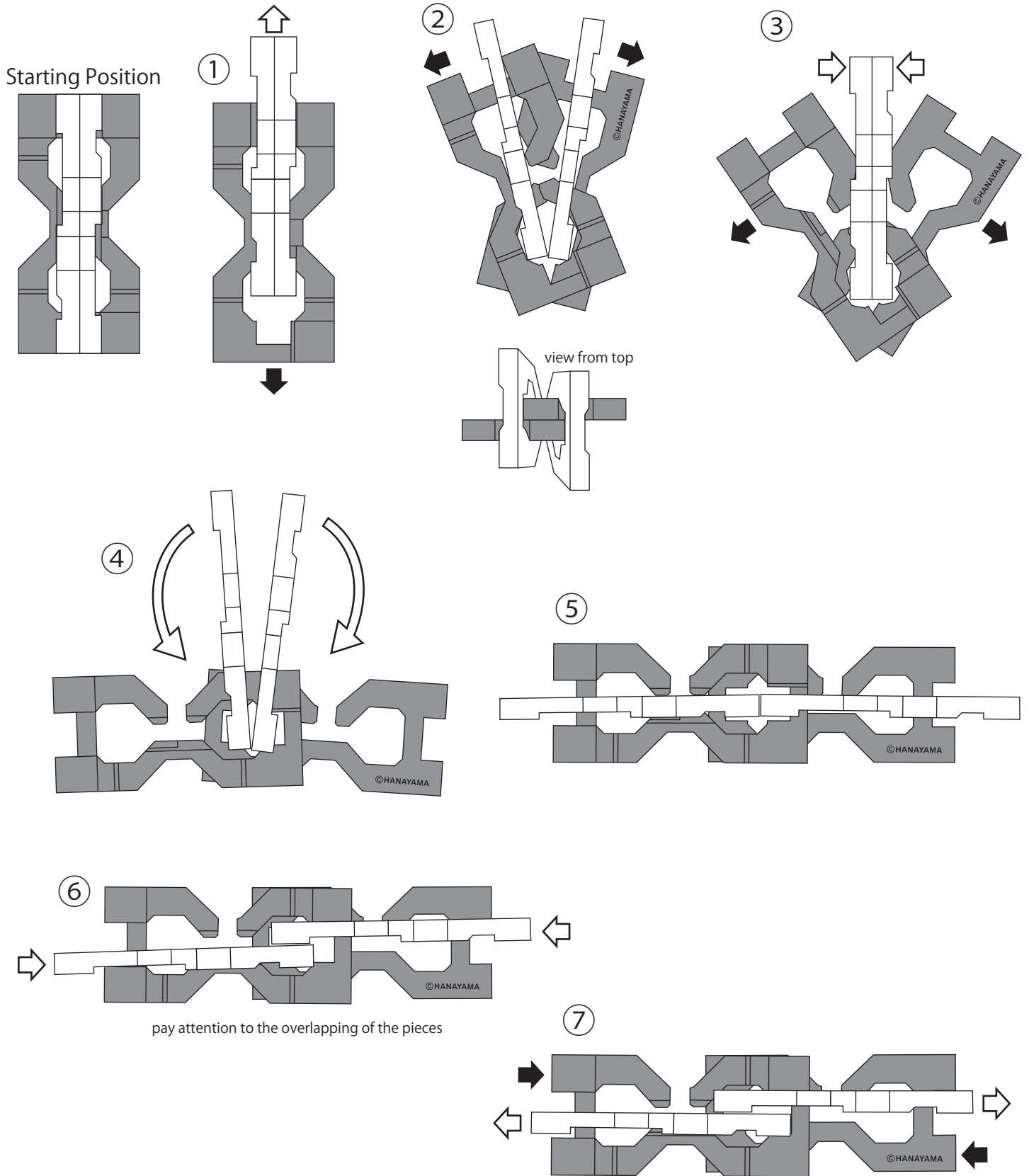

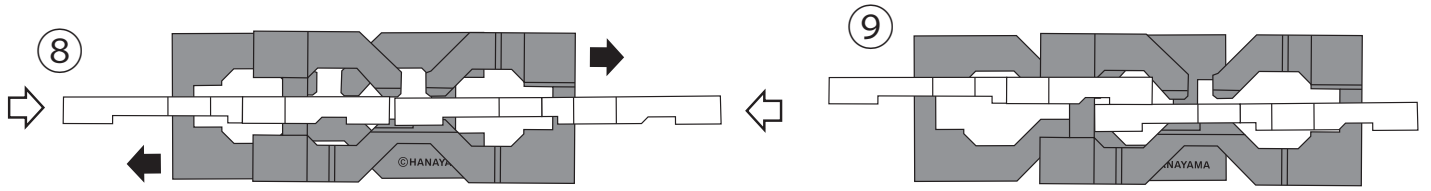

⑩ view of ⑨ from the top

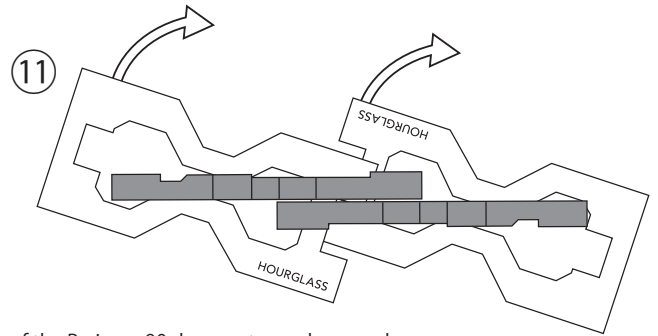
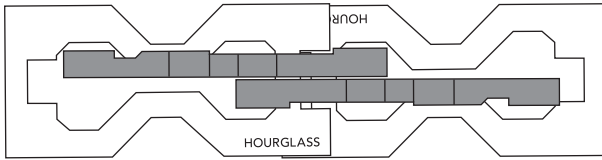

⑫ Push each of the A pieces 90 degrees away and down.

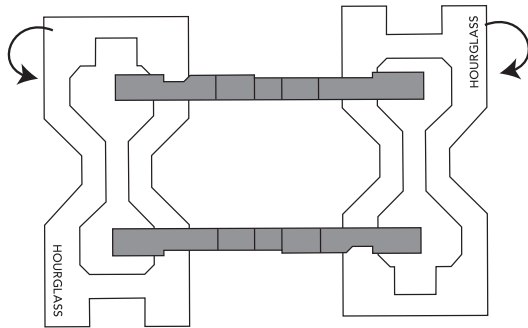

⑬ Bring each of the B pieces 90 degrees toward you and up.

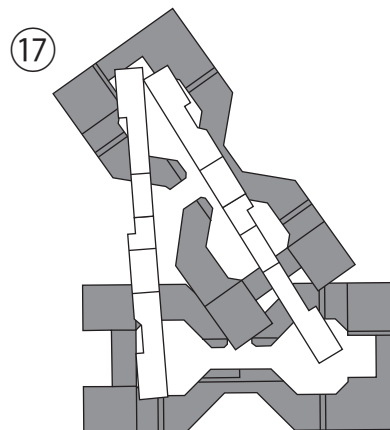
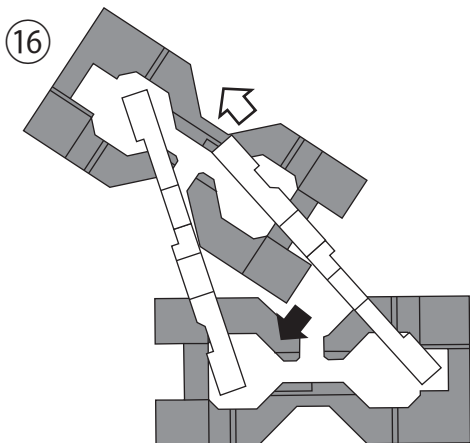
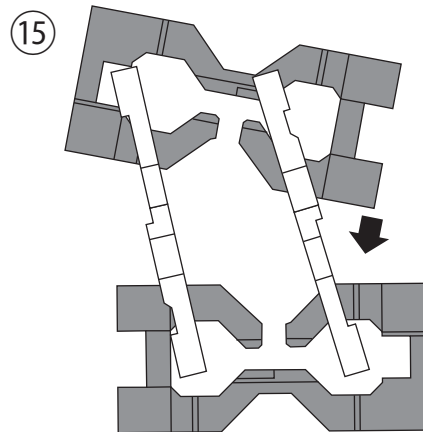
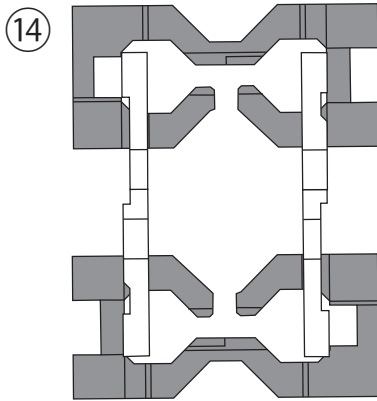
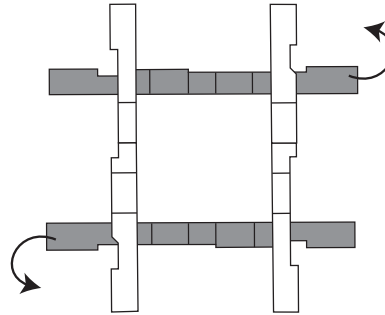

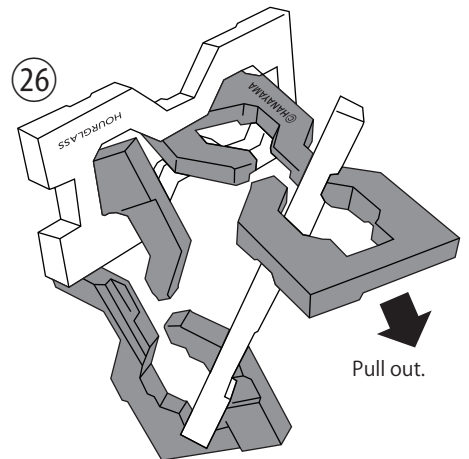
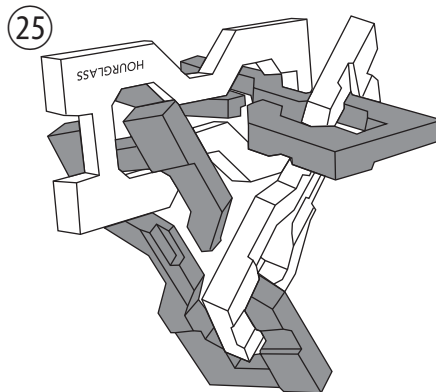
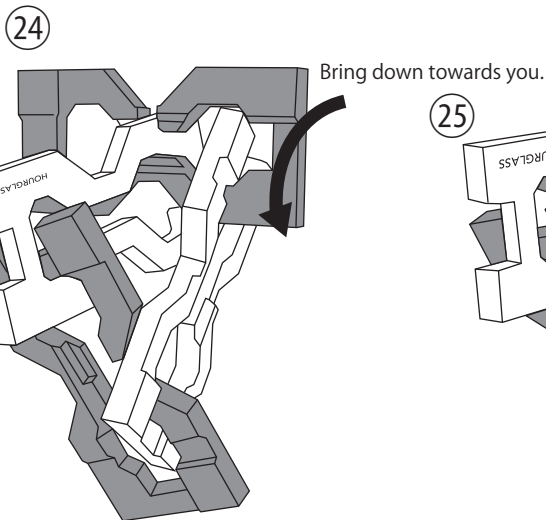
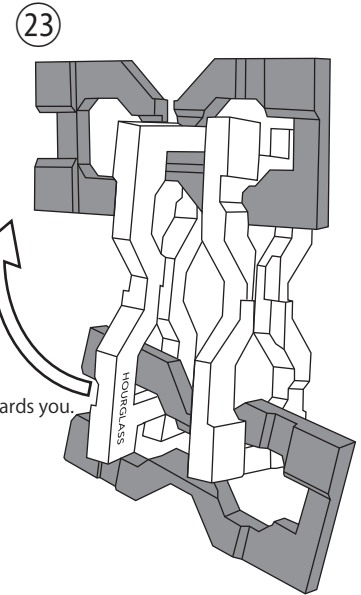
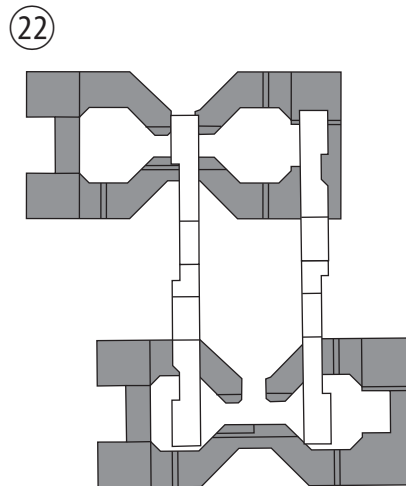
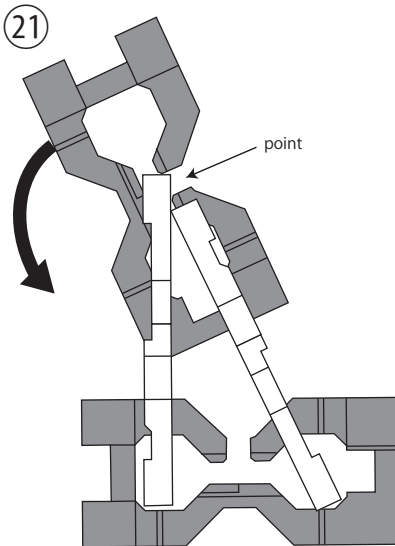
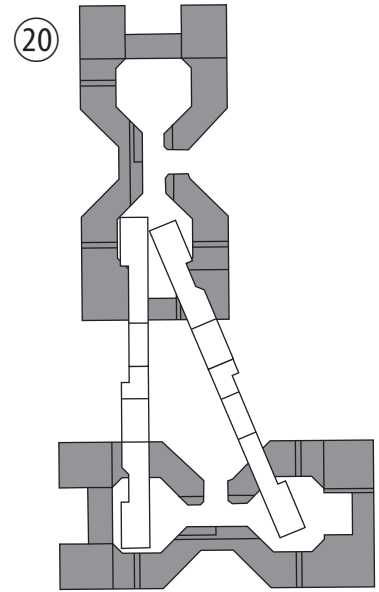
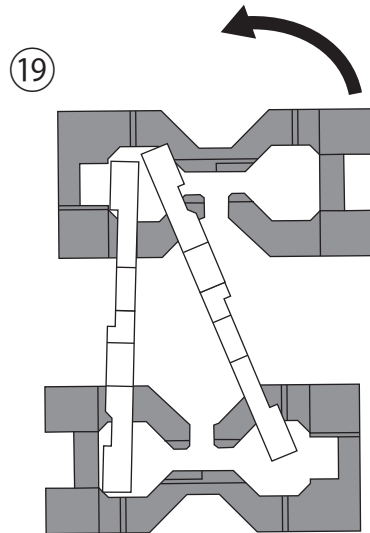
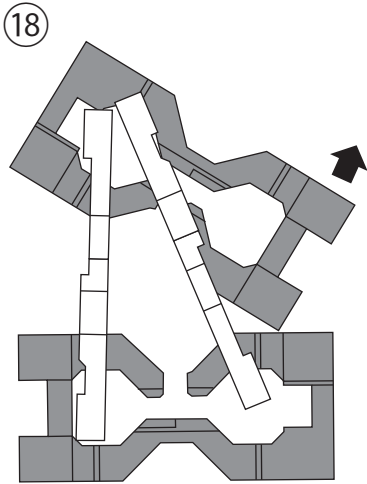

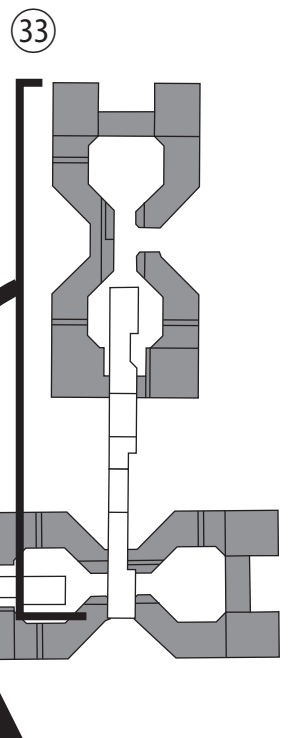
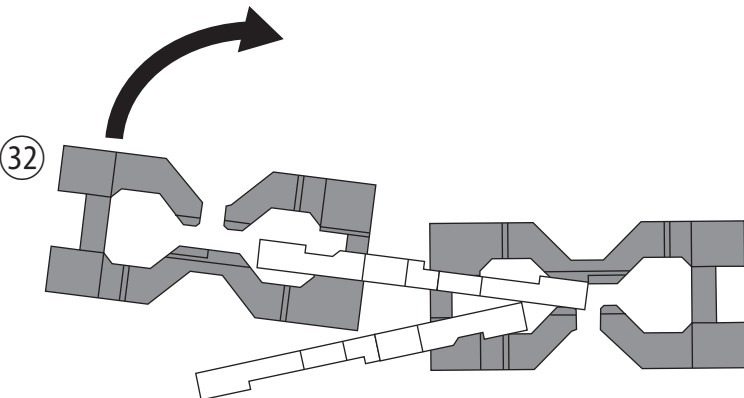
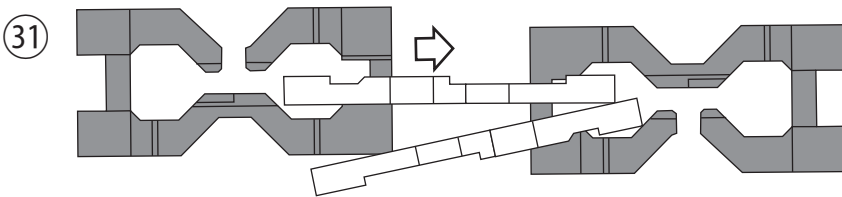
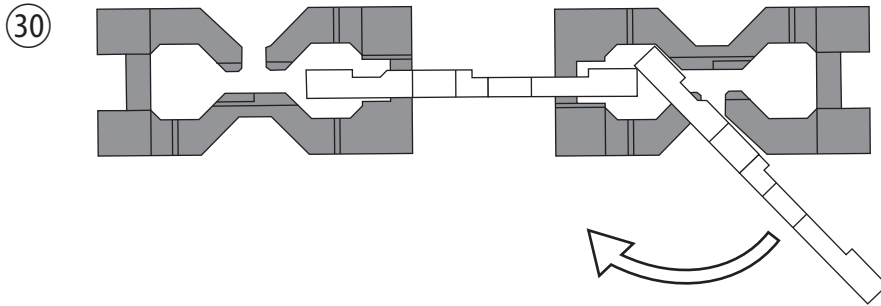
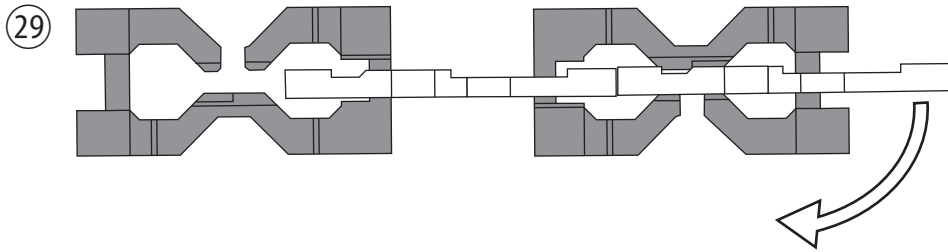
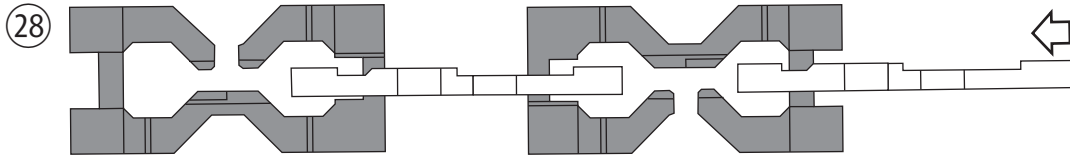
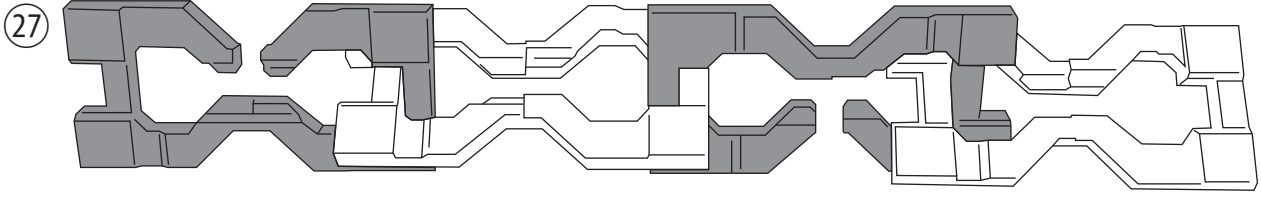

Rotate these two pieces.

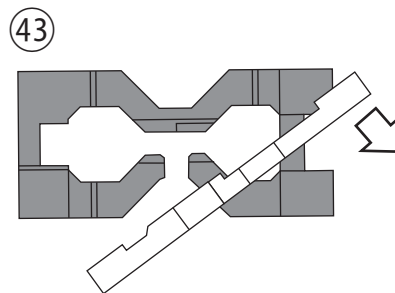
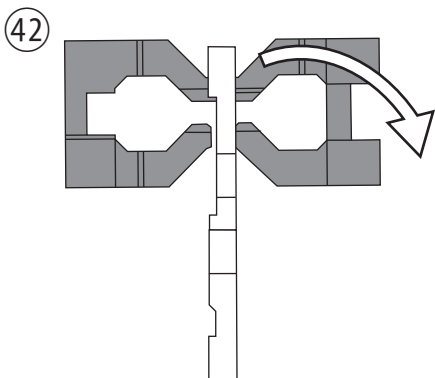
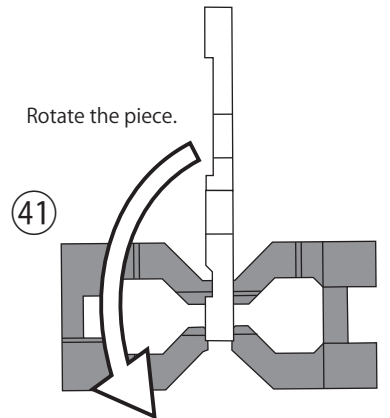
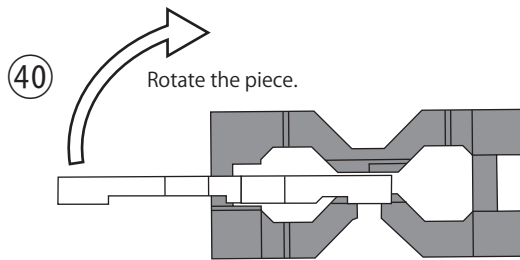
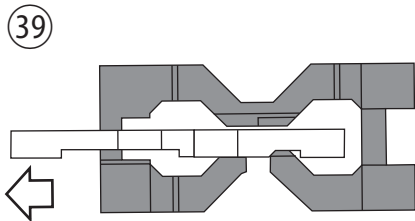
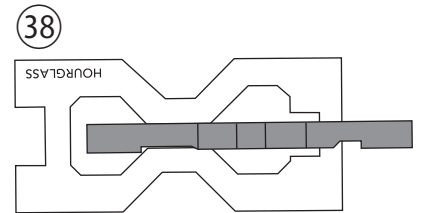
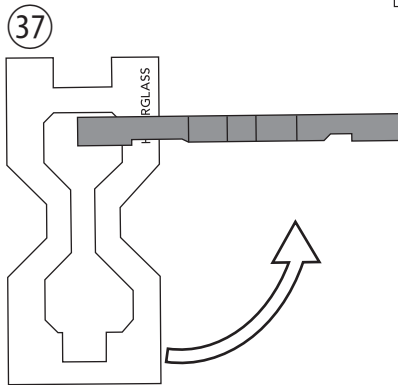
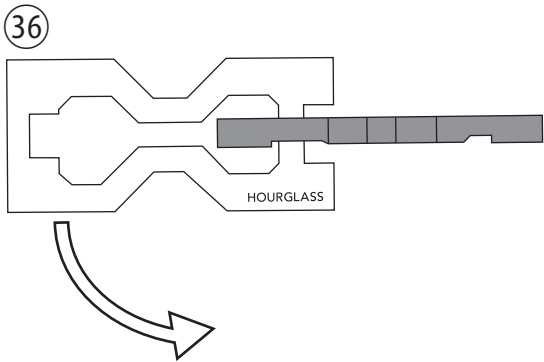
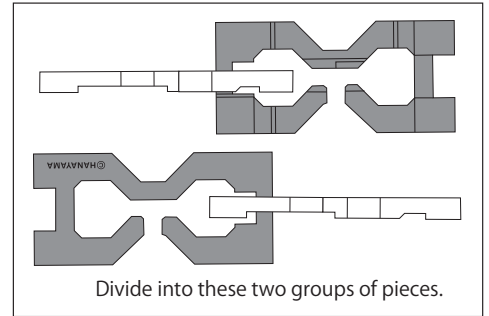
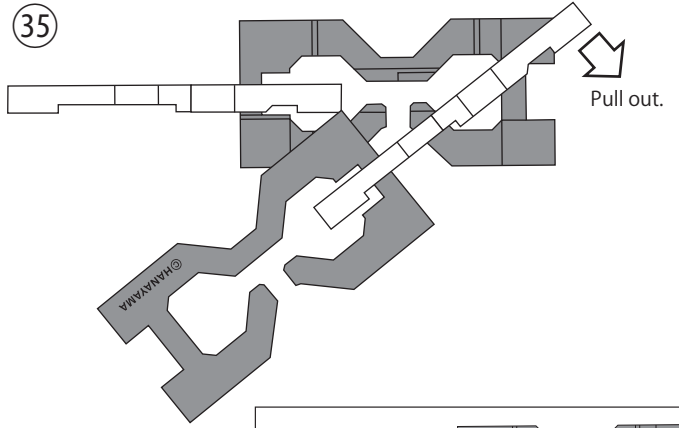
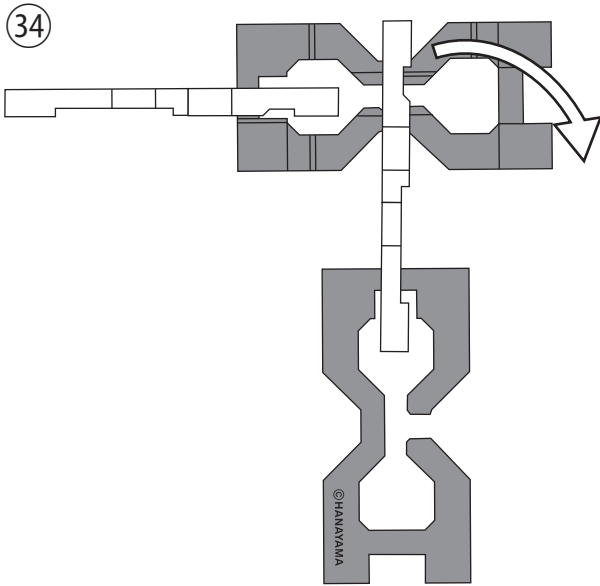

The pieces have been taken apart.  
Take apart the second group in the same way.

